

本体

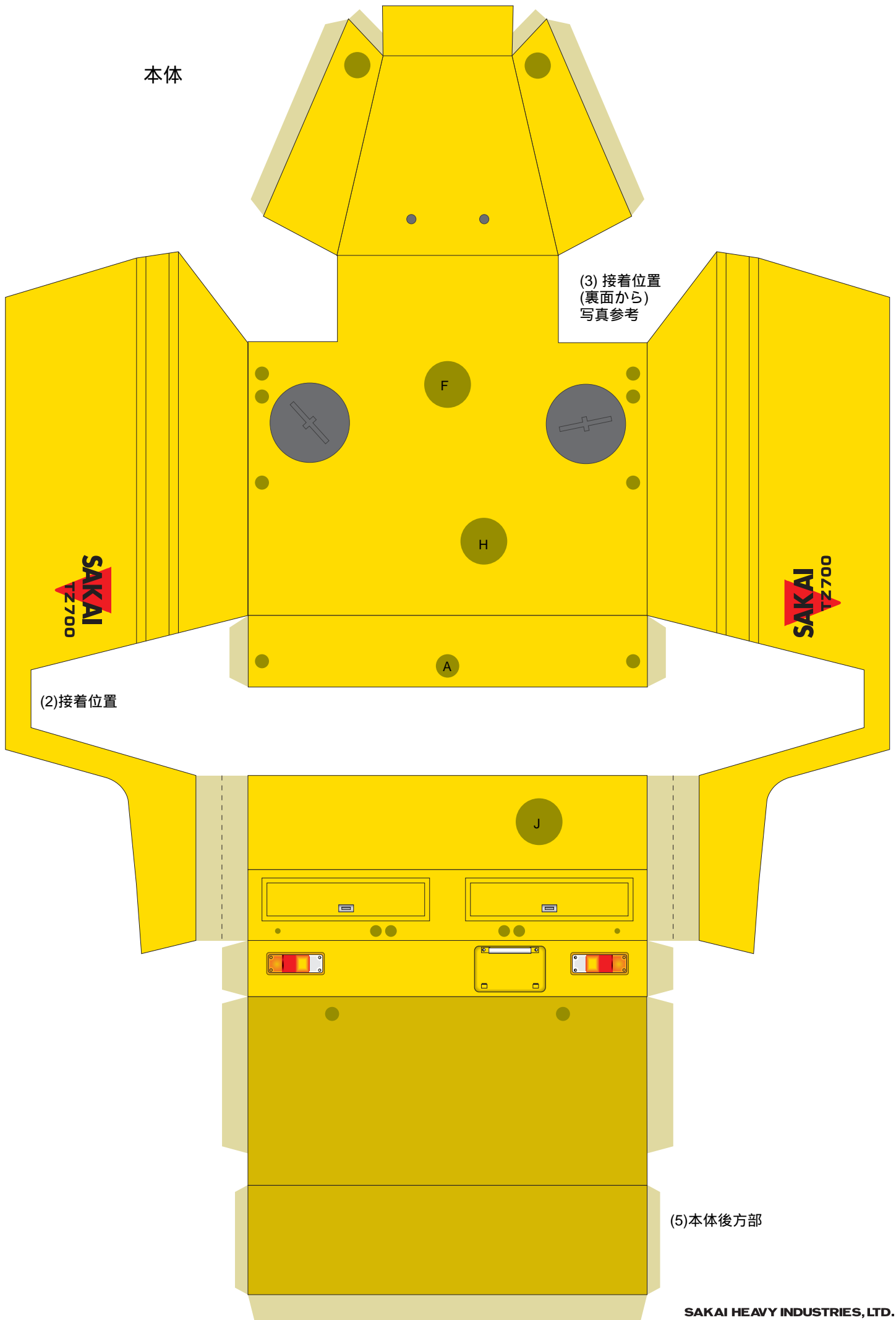

(3) 接着位置  
(裏面から)  
写真参考

(2) 接着位置

(5) 本体後方部

(6)

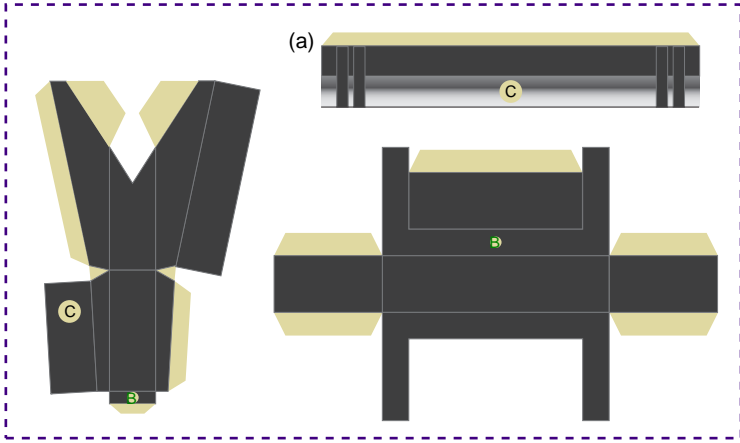

運転席

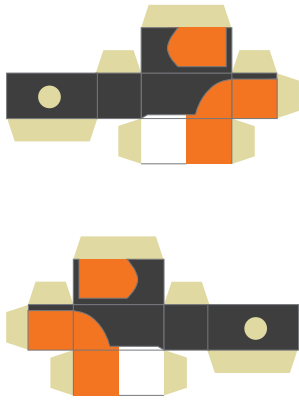
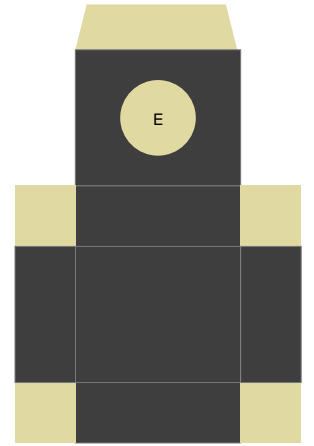

(7)泥除け

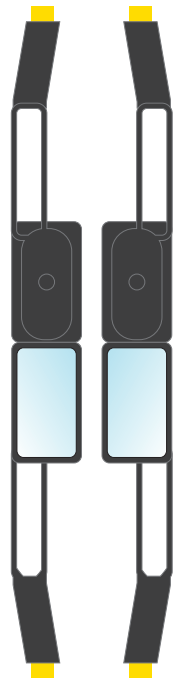
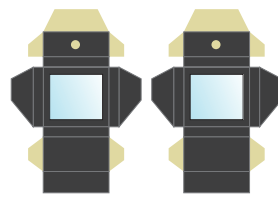
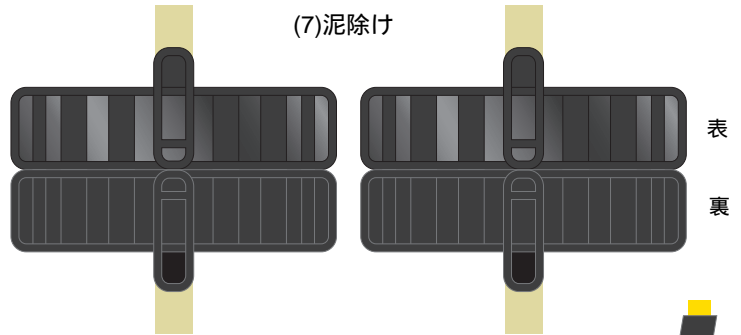

中央ミラー

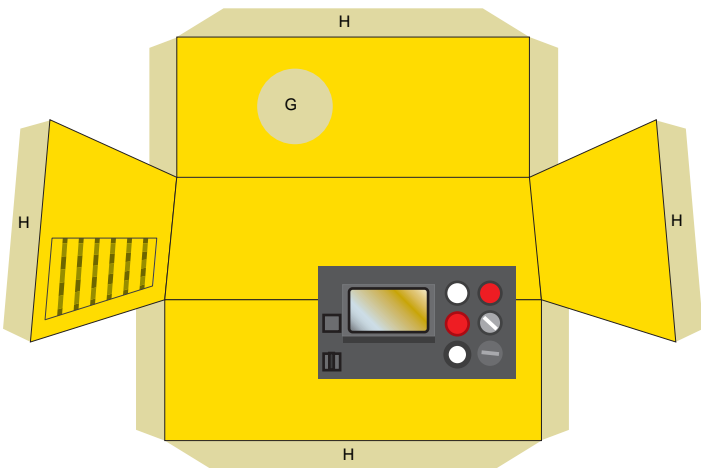
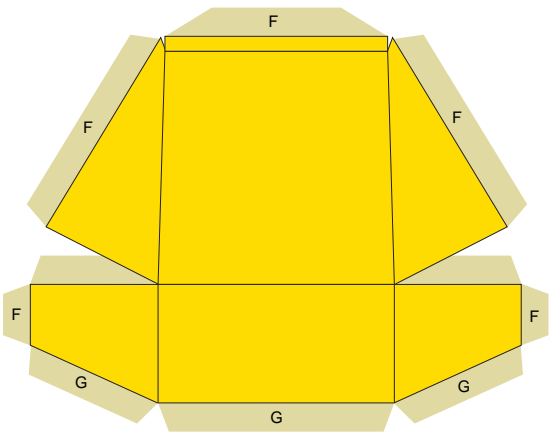

計器板

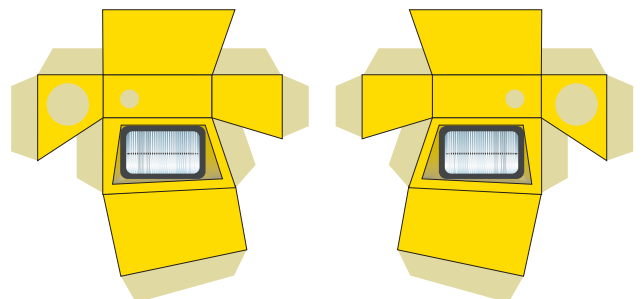

前方ライト

タイヤ

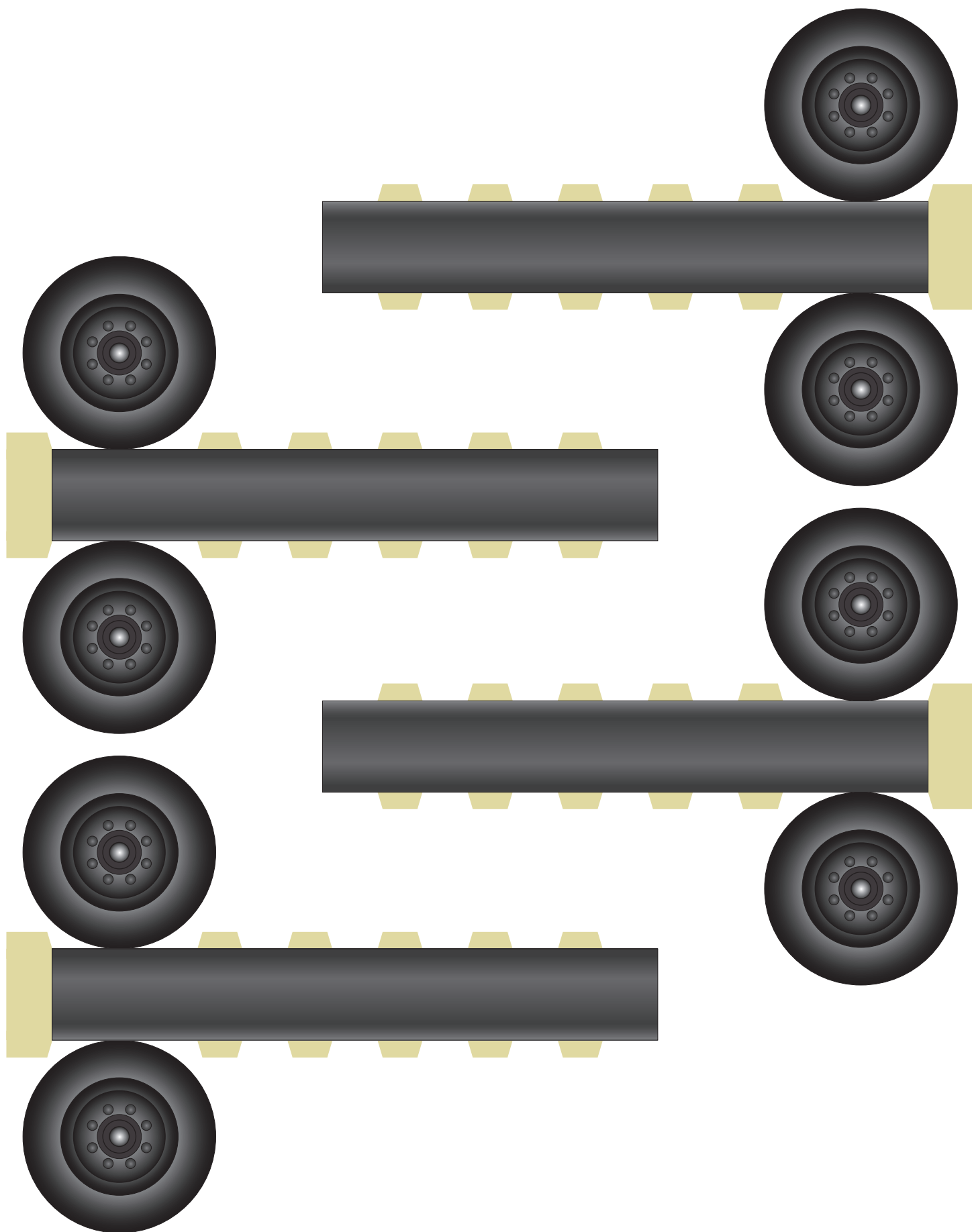

タイヤ

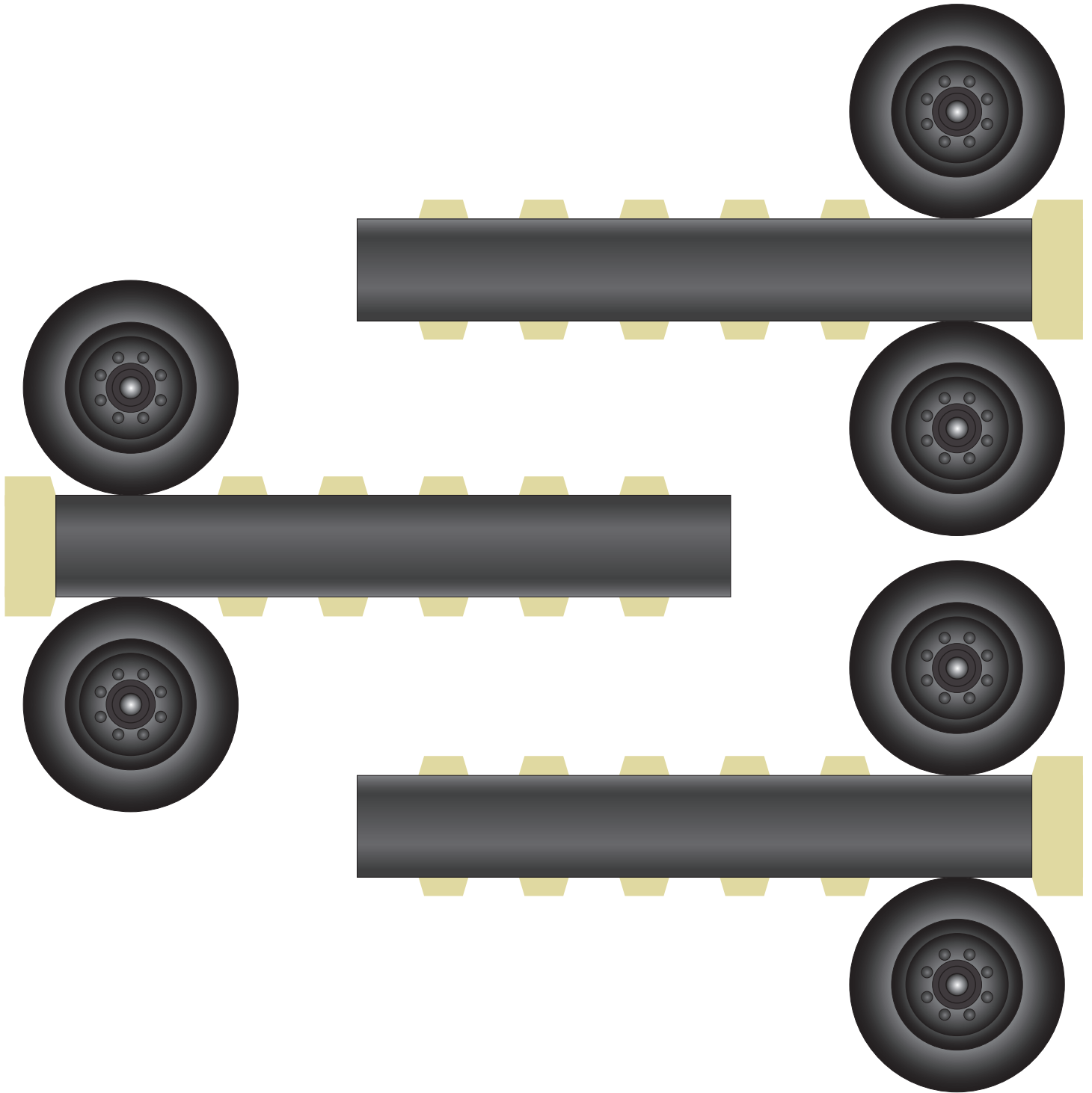

(4)

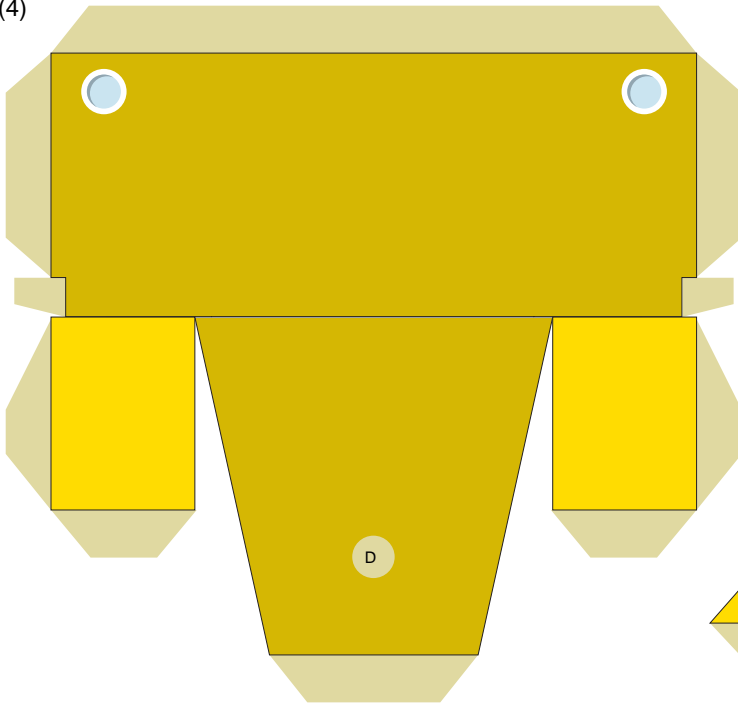

(3)

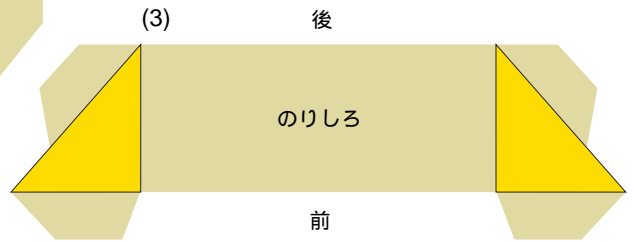

後

のりしろ

前

(2)

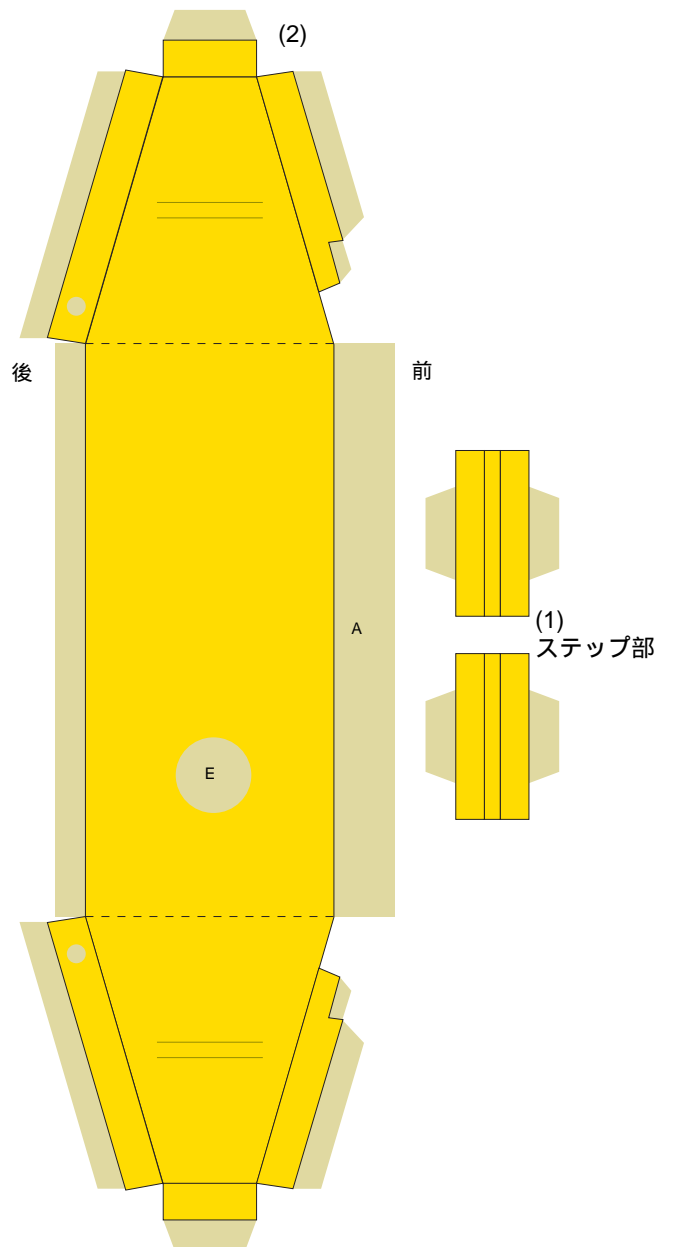

後

前

A

E

(1)  
ステップ部

底面

**SAKAI HEAVY INDUSTRIES, LTD.**

<http://www.sakainet.co.jp>

**TZ700**

後方ミラー

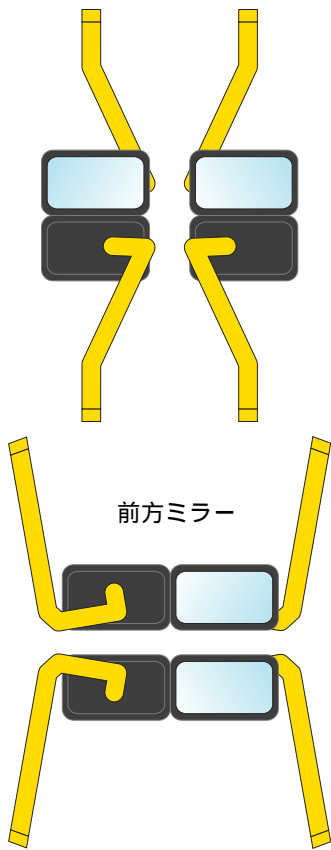

後方パイプ

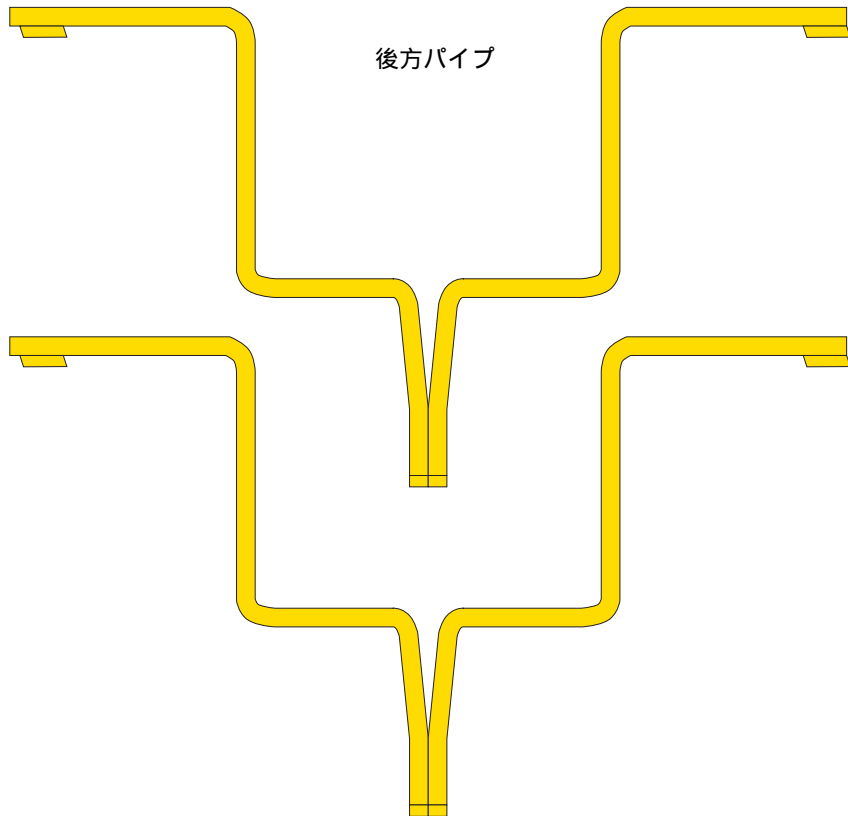

前方ミラー

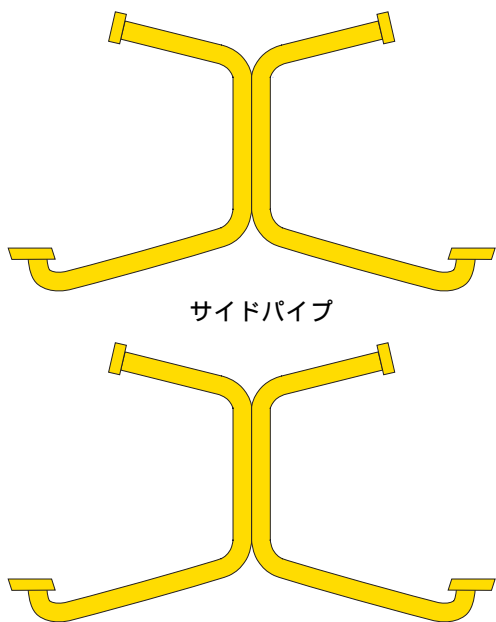

サイドパイプ

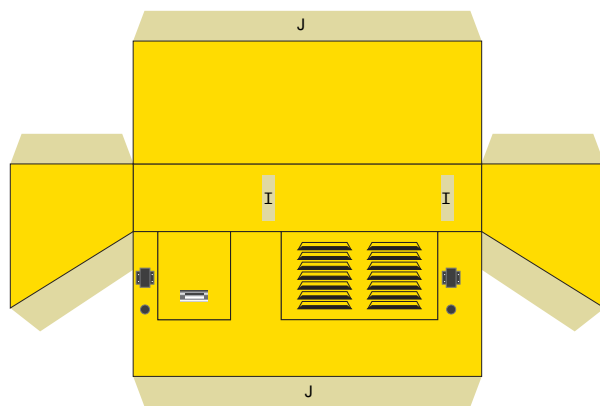

屋根

